

# BH 8 Vibrator

The NAVCO<sup>®</sup> BH 8 is a Pneumatic Piston Vibrator designed to provide reliable and effective performance, even when exposed to severe adverse elements. The size and operating characteristics of the BH 8 make it ideally suited for solving heavy to extreme duty bulk material flow problems.

## Operation and Construction:

The model BH 8 vibrator incorporates a nominal 8" piston and bore. During operation, compressed air is alternately directed from one end of the piston to the other through a series of internal ports. The piston is the only moving part, which makes the pneumatic piston vibrator a reliable, low maintenance device. The vibrator housing is a one piece, ductile iron casting. This adds to the durability and reliability of NAVCO pneumatic piston vibrators.

The action of the piston in a pneumatic piston vibrator generates high amplitude vibration with unidirectional, or linear, force vectors. High amplitude characteristics enable the vibrating energy to be transmitted in the capacity required to overcome the strength of the bulk material involved in a bridge (arch) or a rat hole (pipe). Other advantages of high amplitude, linear vibrators include low utility consumption and minimum bin wall stress.

## Linear vibration offers the following advantages:

The work, or energy generated by the vibrator, can be directed normal, or perpendicular, to the flow of the bulk material to address a specific material flow problem. The vibrator work is used very efficiently to reduce the sliding friction angle of the hopper and to overcome the strength of the bulk material in the hopper. These two factors are key to promoting the flow of bulk solid materials.

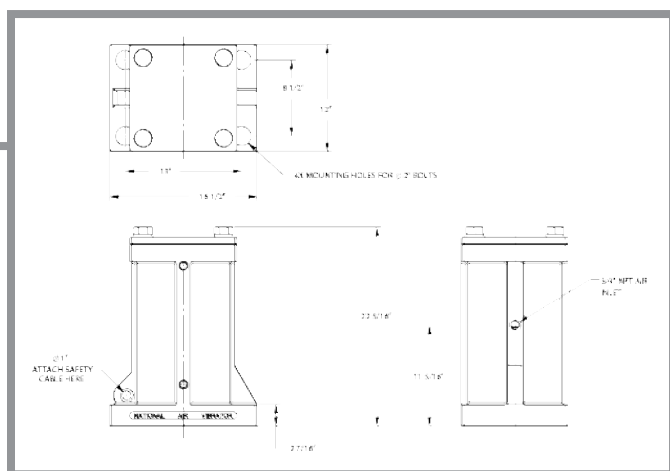

Vibrators that generate linear vibration do not develop high shearing forces at the bin wall. This allows a simple, more direct approach to mounting the vibrators.

Linear vibration is also ideal for driving vibratory feeders and compaction tables.

## Operating Characteristics @ 50 psi

### Frequency

Impacting	850 vpm
Silent	600 vpm

### Air Consumption

Impacting	41 SCFM
Silent	39 SCFM

### Sound Pressure Level

Impacting	88 dBA
Silent	79 dBA

### Sizing Criteria

Hopper Capacity	800 - 1500 ton
Wall Thickness Range	1/2" - 3/4"
Weight	650 lb

## Three Model Types:

### Repetitive Impact BH Vibrator

The Repetitive Impact BH 8 develops a high amplitude repetitive impulse when the piston strikes the base of the bore sharply on each cycle. The piston is air cushioned at the head plate on the upward stroke. Momentum and energy are transmitted efficiently through the bin wall and into the material by each elastic collision between the piston and the vibrator base. The repetitive impacts enable the vibrator to affect material over a large "area of influence", overcoming the bulk material strength and reducing the wall friction angle.

Repetitive Impacting Pneumatic Piston Vibrators are excellent for all bulk material flow problems, especially those involving cohesive materials with marginal to poor flow characteristics. They are also effective in cleaning adhering material from empty bins and process vessels.

### Single Impact BH Vibrator

The Single Impact BH 8 delivers a single, high amplitude impulse each time it is energized. The vibrator can be operated using pneumatic or electronic timers, programmable controllers, or any other device that can deliver an intermittent control signal to the unit. The impulse of a timed impact unit is very effective in evacuating hoppers and process vessels. Specific advantages of Single Impact BH Vibrator is the low noise levels and very low air consumption.

### Silent BH Vibrator

The Silent BH 8 generates a sinusoidal output by creating an air cushion at each end of the piston stroke. NAVCO Silent BH Vibrators are effective in applications involving non-cohesive or free flowing materials where a slight increase in energy is required to initiate or maintain flow. The Silent units are also ideal as drives for vibratory tables and feeders.

## Sizing and Installation

Proper sizing and installation of vibrators are critical to the success of the flow aid system. The three major factors to consider in selecting pneumatic piston vibrators for hopper applications are:

1. Wall thickness of the hopper
2. Volume and mass of material in the hopper
3. Flow characteristics of the bulk material

The NAVCO BH 8 is a heavy to extreme duty vibrator. It may be applied to hoppers with a capacity up to 800 - 1500 tons, with a wall thickness of 1/2" to 3/4". On thinner walls, a smaller unit is recommended. On thicker walls, a larger unit should be selected. The optimal location for a vibrator in a typical hopper application is at the point of the flow restriction.

If the exact point is unknown, the vibrator should be located close to the discharge. For large hoppers, hoppers with unusual geometry, or particularly difficult material flow problems, multiple vibrators may be required. Please consult NAVCO for a complete Bin Map solution in difficult cases.

The vibrator mounting plate should be skip welded to the hopper wall using a low hydrogen welding rod. If reinforcement is required, it should be skip welded, also with a low hydrogen rod.

## Accessories and Options

To ensure proper application and operation of BH Vibrators, a complete line of system accessories are available. The BH 8 has a 3/4" NPT inlet. Refer to the below diagram and bill of materials.

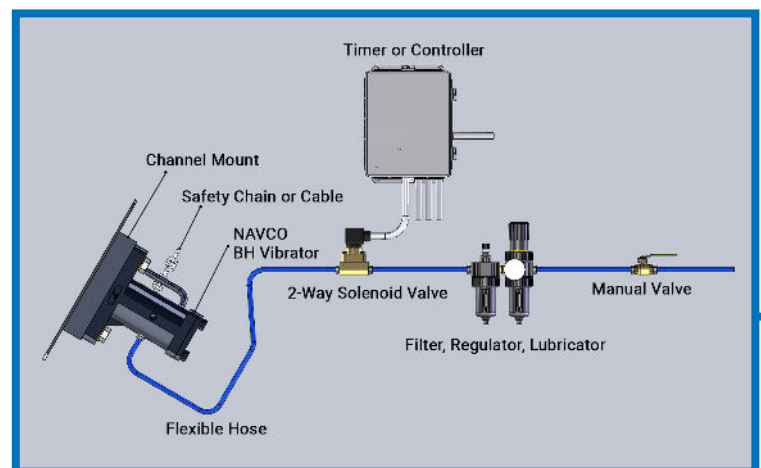

## CONTACT US TODAY AT

E. SALES@NAVCO.US W. NAVCO.US A. 11929 Brittmoore Park Dr.  
P. 832.467.3636 F. 832.467.3800 Houston, TX 77041